

# A Minimalist analysis of possessor advancement

## Baker (1988) revisited

Anke Assmann, Doreen Georgi & Philipp Weisser

In this paper, we show how Baker's (1988) account of noun incorporation, which was formulated in a Government & Binding framework, can be transferred to a modern Minimalist grammar. We argue that the Minimalist theory of noun incorporation does not only have conceptual advantages over a GB analysis — since it requires a smaller number of stipulations — but also empirical ones. The crucial assumption our account is based on is that noun incorporation is triggered by a special kind of case feature on the incorporating noun. This assumption is shown to have major impacts on derivations which involve noun incorporation.

### *1. Introduction*

Scientific progress is a double-edged sword. The adoption of new ideas and theories always carries with it the danger of losing established findings of the previous theories. Especially in syntactic theory, the principles and rules of new frameworks often lead to incompatibility with existing theories. Every theory and every analysis must be questioned whether it can be transferred and adapted to the new framework.

In this paper, we investigate whether Baker's (1988) ground-breaking analysis of incorporation can be recycled and transferred from Government & Binding Theory (GB) to a Minimalist framework. Since his account heavily relies on specific concepts and definitions of GB such as different levels of syntactic representation, a translation of his theory into a Minimalist framework faces several challenges. Nevertheless, it is important to pursue this aim since the important insights that his theory has provided for syntactic theory in general and especially for theory of grammatical function changing processes are worthwhile preserving by transferring it to a modern syntactic framework.

We argue that Baker's whole theory of noun incorporation can in fact be translated into a Minimalist framework but that, nonetheless, several adjustments are necessary. Furthermore, we show that Baker's account is not able to derive the whole agreement pattern of cases of noun incorporation in languages such as Mohawk. As we will argue, this pattern can be explained

by using our Minimalist version of his account. Thereby, we also avoid several stipulations that Baker has to make in his analysis.

The paper is structured as follows. In section 2, we shortly outline Baker's approach to incorporation and grammatical function changing processes. In section 3, we present the relevant data of cases of noun incorporation in Mohawk and show where Baker fails to derive the whole agreement pattern. Furthermore, we show that although his account is a quite elegant solution to the challenges of noun incorporation, he still needs to make several stipulations to make it work. Section 4 deals with all the problems one faces when trying to transfer Baker's GB analysis to a derivational Minimalist framework. We discuss in detail which Minimalist assumptions are problematic for the adoption of his theory and how these problems can be solved. Afterwards we present the background assumptions for our own account and go through all the derivations in detail. Furthermore, we discuss how the problems laid down in the previous sections are solved. In section 5, we address some potential problems for our analysis and open questions. Section 6 concludes.

## 2. Baker's account

Baker (1988) is concerned with cross-linguistic grammatical function changing processes (GFCP) which he analyses as the result of incorporation. For Baker (1988), grammatical functions (GF) are derived notions which are defined as sets of properties resulting from the interaction of GB subtheories like X-bar theory, case theory, binding theory etc. The GF of a nominal category can thus be identified by the case it bears, the structural position it occupies or by looking at whether it triggers verbal agreement or not. Hence, a change of syntactic configurations by a syntactic operation may change the properties of a nominal category and thereby its GF. Processes with such a result are called *grammatical function changing processes*. Based on Baker (1988), we define GFCP as follows:

(1) *Grammatical function changing processes:*

A (nominal) category that has a certain grammatical function  $F$  in the context of a verb with a certain morphology  $M$  in a sentence  $P$  receives another grammatical function  $F'$  in the context of a verb with a different morphology  $M'$  in a sentence  $P'$ .  $P$  and  $P'$  are thematic paraphrases.

The following active-passive-alternation from English illustrates the definition above.

- |     |                                     |                        |
|-----|-------------------------------------|------------------------|
| (2) | a. Rover bit <u>Linda</u> .         | $F = O, M = active$    |
|     | b. <u>Linda</u> was bitten by Rover | $F' = S, M' = passive$ |
|     |                                     | Baker (1988:7)         |

Both sentences express the same proposition and are thus thematic paraphrases. However, the arguments *Rover* and *Linda* receive different grammatical functions in both sentences. In example (2-a), *Linda* is the direct object and in (2-b), the passivised counterpart of (2-a) — *Linda* — is the subject. *Rover*, on the other hand, is the subject of the first example but in the second example it is realised as an oblique category within a prepositional phrase. Both arguments receive

different grammatical functions in the passivised example (2-b).

The next examples from Chichewa illustrate the same point for another GFCP, namely causativisation:

(3) *Chichewa* (Baker 1988:148):<sup>1</sup>

- a. Mtsikana ana-chit-its-a kuti mtsuko u-gw-e.  
 girl AGR-do-make-ASP that waterpot AGR-fall-ASP  
 ‘The girl made the waterpot fall.’ *F = S, M = non-causative*
- b. Mtsikana anau-gw-ets-a mtsuko.  
 girl AGR-fall-made-ASP waterpot  
 ‘The girl made the waterpot fall.’ *F' = DO, M' = causative*

In (3), both examples express the same proposition and are thus thematic paraphrases. In example (3-a), the underlined argument *mtsuko* is the subject of the embedded clause but in example (3-b), which is now monoclausal, it is the direct object of the complex verb.

The causative/non-causative alternation can be used to illustrate Baker’s account. The central assumption in Baker (1988) is that all kinds of GFCPs are a side-effect of incorporation. In the case of causativisation, Baker assumes that the verb of the embedded clause incorporates into the matrix verb. In the Chichewa examples, the stem of the embedded verb *-gw-* incorporates into the matrix verb *-its-*. The result is a monoclausal structure with *mtsuko* as a direct object.

Another example of a GFCP and the topic of this paper is a process traditionally called *possessor ascension* or *possessor advancement*<sup>2</sup> (cf. Allen & Frantz (1978); Robinson (1980); Aissen (1987); Blake (1990); Rosen (1990); Frantz et al. (1990) among many others) in noun incorporation structures.

(4) *Mohawk*:

- a. Ka-rakv ne sawatis hrao-nuhs-a?  
 3N-be.white DET John.M 3M-house.N-SUF  
 ‘John’s house is white.’ Baker (1988:97)
- b. Hrao-nuhs-rakv ne sawatis.  
 3M-house.N-be.white DET John.M  
 ‘John’s house is white.’ Baker (1988:96)

Again, both sentences are thematic paraphrases. In example (4-a), the unaccusative verb *rakv* (‘be white’) and its internal argument are distinct words and the verb shows neuter agreement (*ka-*) indicating that the head of its only argument is the neuter noun *nuhs* (‘house’). The noun *nuhs* (‘house’) is marked for agreement (*hrao-*) with its masculine possessor *sawatis* (‘John’). However, in the second example (4-b), the head noun *nuhs* has incorporated into the verb, stranding its determiner and possessor. Furthermore, the verb no longer shows neuter agreement

<sup>1</sup>Throughout this paper, we use the following glosses and abbreviations (most of the glosses are adopted from the cited literature): 1, 2, 3 1st, 2nd, 3rd person; ABS absolutive; ACC accusative; AGR agreement morphology; ASP aspect; DET determiner; F feminine; GEN genitive; M masculine; MA Finnish MA-infinitival; N neuter; NOM nominative; O object; PRE unspecified prefix; PRT partitive; S subject; SG singular; SUF undetermined suffix; VA Finnish VA-infinitival; *e* empty category; *Poss* possessor *t* trace;  $\varphi$  phi-features (person, number, gender).

<sup>2</sup>In what follows, we take both terms to be completely interchangeable.

but masculine agreement (*hrao-*) since it agrees now with the possessor of its only argument. The possessor *sawatis* ('John') in (4-b) behaves like the head noun *nuhs* ('house') in (4-a) with respect to agreement: both trigger verbal agreement and can thus be said to have the GF *direct object*. That is, the possessor has undergone a GFCP and has become the direct object of the verb under noun incorporation.

Baker's (1988) aim is to develop a unified analysis for all GFCPs and to derive restrictions on the processes by the interaction of independently motivated principles of grammar. He proposes that all GFCPs are derived by incorporation which he analyses as head movement. GF changing is a side-effect of this movement. As an instance of Move  $\alpha$ , incorporation is subject to the same constraints as other types of head movement. This derives many of the properties of GF changing (distribution of incorporation, morphological reflexes, (im)possible GFCPs, order of GFCPs, etc.). In order to understand Baker's proposal, which is rooted in the GB framework, we must briefly recapitulate some of its major background assumptions first. The syntactic model comprises four different levels of representation: D(eep)-structure, S(urface)-structure, phonological form (PF) and logical form (LF). D-structure and S-structure are related by the operation Move  $\alpha$ . The *Projection Principle* in (5) has the effect that movement must leave a trace.

(5) *Projection Principle:*

Lexical selection properties of an item must be represented at each syntactic level of representation. Chomsky (1981:29)

The structure of syntactic trees is constrained by the X-bar schema which says that an XP must have a head which can additionally select a complement and at most one specifier:

(6)  $[_{XP} (YP) [_{X'} X (ZP) ]]$

A further important assumption of Baker (1988) is the *Uniformity of Theta Assignment Hypothesis* (UTAH) in (7). It basically says that arguments bearing the same thematic roles have to be located in the same syntactic positions at D-structure.

(7) *Uniformity of Theta Assignment Hypothesis:*

Identical thematic relationships between items are represented by identical structural relationships between those items at the level of D-structure. Baker (1988:46)

With these ingredients, the GFCP possessor advancement in (4) is derived as follows: Due to the UTAH, (4-a) and (4-b) must have the same underlying structure because they are thematic phrases. Hence, (4-b) is derived from (4-a) by head movement (incorporation) of the head noun 'house' into the verb 'white' as illustrated in (8) and (9).<sup>3</sup> In accordance with the *Projection Principle*, this movement leaves a trace in N's base position.

---

<sup>3</sup>A further assumption is that the subject position is already present at D-structure and filled by an empty category *e*. Movement of the complement of V to this position replaces the empty category at S-structure.

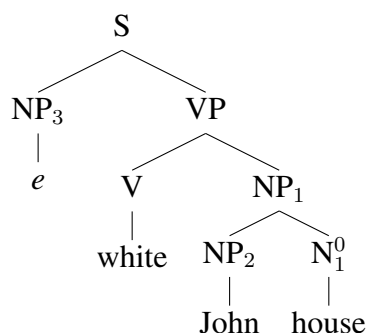
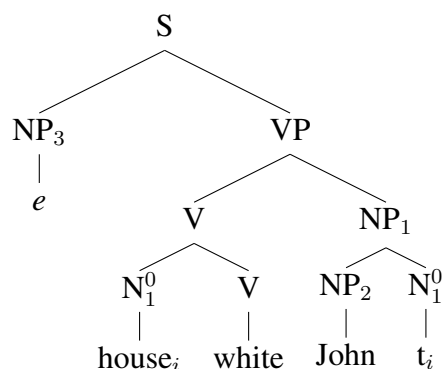
(8) *D-structure:*(9) *S-structure:*

The question is how the GFs of the nominal elements are changed. The GFs in Mohawk can be identified via verbal agreement. A prerequisite for agreement between a verbal head and an NP is that the verb governs the corresponding noun. In (8), given Baker's definition of government, V governs NP<sub>1</sub> and N<sub>1</sub><sup>0</sup> but nothing else contained in NP<sub>1</sub>, especially not the possessor (NP<sub>2</sub>). NP<sub>1</sub> is a barrier for government of V into NP<sub>1</sub>. Hence, there is only agreement between V and the head noun N<sub>1</sub><sup>0</sup> of its complement in (8). If incorporation applies as in (9), the government relations change. If the head X of a barrier XP is moved out of XP, XP ceases to be a barrier.<sup>4</sup> This consequence of incorporation, which follows from the definition of barrier and the fact that incorporation is head movement, is formulated in the *Government Transparency Corollary* (GTC).

<sup>4</sup>The exact definition of barrier used by Baker (1988) is given in (i).

- (i) *Barrier* (Baker 1988:56):  
Let D be the smallest maximal projection containing A. Then C is a barrier between A and B if and only if C is a maximal projection that contains B and excludes A, and either:
- C is not selected, or
  - the head of C is distinct from the head of D and selects some WP equal to or containing B.
- (ii) *Selection* (Baker 1988:57):  
A selects B if and only if:
- A assigns a theta role to B, or
  - A is of category C and B is its IP, or
  - A is of category I and B is its VP.

For the case of possessor advancement in (8) and (9), the definition in (i) says (D = VP, A = V, B = N<sub>1</sub><sup>0</sup>, C = NP<sub>1</sub>) that NP<sub>1</sub> in (8) is a barrier between V and Poss because the head of NP<sub>1</sub> (N<sub>1</sub><sup>0</sup>) is distinct from V, i.e., no head movement has applied. Now, the definition of government in (iii) says that V does not govern Poss and, therefore, cannot assign Case to Poss assuming that Case assignment is possible only under government.

- (iii) *Government* Baker (1988:39), Chomsky (1986a):  
A governs B iff A c-commands B and there is no category C such that C is a barrier between A and B.

In (9), the head of NP<sub>1</sub> is no longer distinct from V due to head movement. Therefore, NP<sub>1</sub> ceases to be a barrier and V can govern Poss.

(10) *The Government Transparency Corollary:*

A lexical category which has an item incorporated into it governs everything which the incorporated item governed in its original structural position. Baker (1988:64)

The result is that after noun incorporation (NI), V governs the possessor (NP<sub>2</sub>) of its complement (NP<sub>1</sub>) and hence, agreement between the two elements is possible. GFCPs thus follow elegantly from the treatment of GFCP as head movement and the independently motivated definition of government. As movement changes syntactic configurations and government is sensitive to these configurations, movement also changes government relations which in turn can give rise to new dependencies that are morphologically expressed, e.g. as  $\varphi$ -agreement in Mohawk. There is thus no raising or advancement of the possessor to the direct object position as in traditional descriptions of the phenomenon. Rather, the GF direct object is defined by properties like having accusative case or, in the case of Mohawk, triggering agreement on V. Thus, if the syntactic configuration changes due to movement, it is not necessarily the complement NP of V but another category, namely Poss, that requires the status of a direct object.

In this section, we have briefly sketched how Baker's account of incorporation works. Noun incorporation is implemented as head movement. The head noun moves out of the object position and adjoins to the verbal head. This kind of head movement also enables possessor ascension inasmuch as it renders the NP<sub>1</sub> barrier transparent for the government relation between the verb and the possessor (NP<sub>2</sub>) contained inside NP<sub>1</sub>. This is needed to trigger processes that result in object properties of the possessor ( $\varphi$ -agreement). In this way, Baker derives the cross-linguistically robust tendency that possessor ascension depends on incorporation of the respective head noun.

3. *Noun incorporation in Mohawk*3.1. *The agreement pattern*

We have already seen a part of the empirical pattern of noun incorporation in Mohawk. But let us briefly repeat the relevant data in order to give a systematic overview. In structures in which the verb selects a direct object with a possessor, the GF changing of the possessor depends on whether the head noun incorporates or not. If the head noun stays in situ (cf. (11-a)), 'possessor ascension' (verbal agreement triggered by the possessor) is *impossible*, the verb can only agree with the head noun. If the head noun incorporates into the verb (cf. (11-b)), 'possessor ascension' *must* apply, agreement between the verb and the head noun is no longer possible.

(11) *Examples with a possessor:*<sup>5</sup>

- a. Iʔi k-ohres ne iʔi wak-nuhs-a?  
 I 1SG.S/3NO-wash DET I 1SG-house.N-SUF  
 'I washed my house' Baker (1988:101)
- b. Wa-hi-ʔsereht-anvhsko  
 PAST-3MS/1SG.O-car-steal  
 'He stole my car' Baker (1988:98)

<sup>5</sup>In (11-b), the possessor is not expressed overtly in contrast to (11-a). Mohawk is an object *pro-drop* language where the direct object can be dropped if it is pronominal (Baker 1996; Markman 2009). This is further evidence that the possessor behaves like the direct object if the noun has incorporated into the verb.

Let us turn to examples without possessors. The following examples show that if there is no possessor, the verb always agrees with the head noun of its internal argument regardless of whether it incorporates or not. In (12-a), the internal argument has not incorporated and the verb agrees with it. But in (12-b) the verb also agrees with it even though the internal argument has incorporated. (13) summarises the agreement pattern of Mohawk in cases of noun incorporation.

(12) *Examples without a possessor:*

a. Yao-wir-a?a ye-nuhwe?-s ne ka-nuhs-a?  
 PRE-baby-SUF 3FS/3N-like-ASP the PRE-house.N-SUF  
 ‘The baby likes the house.’

b. Yao-wir-a?a ye-nuhs-nuhwe?-s  
 PRE-baby-SUF 3FS/3N-house.N-like-ASP  
 ‘The baby likes the house.’

Baker (1988:81f.)

(13) *Agreement pattern of Mohawk*

If NP has *no* possessor, there is *always* agreement between the verb and the head noun regardless of whether incorporation occurs or not (cf. (12)).

If NP has *a* possessor,

*either* the verb agrees with the head noun and the head noun with the possessor and there is no incorporation (cf. (11-a))

*or* the verb agrees with the possessor, the head noun *does not* agree with the possessor and the head noun is incorporated into the verb (cf. (11-b)).

The other two logically possible patterns in structures with a possessor in the NP are excluded (V-N-agreement with incorporation and V-Poss-agreement without incorporation). Put differently, the pattern can be condensed to the following formula when there is a possessor in the NP. This observation will be crucial for our analysis.

(14) *Agreement rule in Mohawk*

If the head noun incorporates it cannot agree with the possessor.

Baker (1988) can derive the fact that N-V-agreement is impossible under noun incorporation in structures with a possessor. In order to do so, he assumes that NPs have to pass a Case filter<sup>6</sup> (Rouveret & Vergnaud 1980; Chomsky 1980, 1986b), i.e., in Mohawk, they must trigger agreement on a head in order to be visible at LF. Baker stipulates that incorporation, i.e. head movement, is one way to pass the Case filter. Furthermore, he implicitly assumes that V can only agree with one category — NP or Poss — and that the incorporated N cannot agree with Poss. Now, if in a structure with a possessor, the incorporated head noun would agree with V, Poss would not pass the Case Filter since it has not triggered agreement on any category. Thus, the only possibility is that the possessor agrees with the verb in structures with incorporation. In this case NP satisfies the Case Filter because its head has incorporated.

<sup>6</sup>The Case Filter or the Visibility Condition for NPs says that an NP is only visible on LF if it has Case (cf. Baker 1988:41).

However, since head movement is already sufficient to pass the Case Filter, Baker (1988) cannot explain why in structures without a possessor, agreement between  $N^0$  and V is obligatory. Nevertheless, this crucial generalisation about the agreement pattern in Mohawk needs to be accounted for.

### 3.2. Challenges for Baker's analysis of NI in Mohawk

In the last section, we gave a summary of the noun incorporation data in Mohawk which will be the basis for our own account. But before we will start to outline our approach, we briefly discuss some of the problems and possible criticisms of Baker's analysis.

Let us begin with the critique of formal properties of his account. The first criticism is that Baker has to stipulate that neither the trace of the dislocated head noun nor the dislocated head noun itself can assign case to the possessor.<sup>7</sup> If they could, the possessor would get genitive Case from the head noun and the verb would assign Case to the head noun after the head noun has incorporated. This is a pattern which is not attested in Mohawk because if the head noun incorporates, the verb must agree with the possessor or put as in (14), the noun cannot agree with the possessor. Take a look at the following tree. It shows the situation after incorporation has applied.

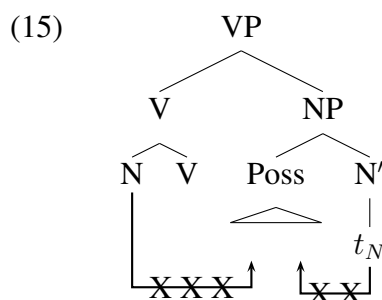

The question is now why neither the trace nor the head-moved element can assign genitive Case to its possessor. Basically, there is no obvious reason why this should be prevented. First of all, according to Baker's definition of government, N should be able to govern the possessor from its landing site because the NP barrier is broken up. Note further that the incorporated N and V have the same distance to the possessor since N and V c-command each other such that locality does not explain either why the incorporated N cannot assign Case to the possessor. There is also no independent reason why the trace of N should not enter into a relation with the possessor. Baker has identified these problems himself and he has given the following (stipulated) constraints:

(16) *Case Frame Preservation Principle:*

A complex  $X^0$  of category A in a given language can have at most the maximal Case-assigning properties allowed to a morphologically simple item of category A in that language. Baker (1988:122)

(17) Traces cannot assign Case.

Baker (1988:99)

<sup>7</sup>In the following discussion, we follow Baker in that 'Case' stands for abstract case which can be realised language-specifically by morphological 'case', agreement marking on the Case assigner or positioning of the Case-marked phrase in relation to the Case assigner (cf. Baker 1988:115). Since in the case of Mohawk, accusative 'Case' is realised by agreement between the direct object and the verb, we use the terms Case assignment and agreement interchangeably.



The Case Frame Preservation Principle basically says that a head keeps its Case-assigning properties when another Case-assigning head adjoins to it, viz. the number of Cases that the target head assigns is not augmented. In our case that means that the verb still assigns only accusative Case even if a head noun which assigns genitive Case has incorporated into it. Hence, the Case-assigning property of N depends on its position in the syntactic structure. The second constraint ensures that the trace of a moved N does not bear the Case-assigning property of N. Whether this is plausible or not probably depends on how the Move  $\alpha$  operation is implemented.<sup>8</sup>

A final stipulation Baker has to make is that head movement suffices to satisfy the Case filter. This stipulation is crucial for Baker since without it, he cannot derive the fact that agreement between V and Poss is possible if the head noun has incorporated into V. If incorporation would not satisfy the Case filter, NP would get no Case if V agrees with Poss or Poss would get no Case if V agrees with N.

As we have already indicated in the previous section, the last point of our critique concerns the point that Baker's theory can derive most of but not the whole agreement pattern in Mohawk. As far as we can see, at least for Mohawk his theory does not make the right predictions in all cases. We have seen how his approach elegantly accounts for the fact that the verb can agree with the possessor under noun incorporation: if the head noun incorporates, the NP being a barrier is no longer opaque for government from the verb. Furthermore, he can explain why V can no longer assign Case to the incorporated head noun in structures with a possessor. However, his analysis makes the prediction that N-V-agreement in structures without a possessor is at most optional.<sup>9</sup>

#### 4. Analysing NI in a Minimalist framework

##### 4.1. Problems with transferring Baker's theory to a Minimalist framework

Up to this point we have discussed the data of noun incorporation in Mohawk and Baker's approach to derive them. We have seen that his analysis heavily relies on the GB framework in which it was formulated and that it needs some stipulations to work. In this chapter, we are going to discuss in detail which parts of the analysis can be maintained and which must be adapted if one wants to transfer Baker's analysis to a Minimalist framework. In doing so, we are paving the way for our own account which will be presented afterwards.

Before laying out the problems of transferring Baker's analysis to Minimalism, it is necessary to summarise some basic assumptions of recent developments of this framework (Chomsky 1995, 2000, 2001, 2008). First of all, syntactic structure unfolds bottom-up by alternating applications of the basic operations Merge, Move and Agree. These operations are in accordance with the *Strict Cycle Condition* (Chomsky 1973) in (18) and as the derivation is generated step by step, there can be no look-ahead to items which are not merged at a certain point of the

<sup>8</sup>When using a Move  $\alpha$  operation which involves actual movement of the head noun including all its features as indicated in (15) and when Case can only be assigned at S-structure, (17) can probably be derived in a quite plausible manner but under the assumption that movement involves copies (cf. the discussion in Chomsky 1981:89), (17) seems completely ad hoc.

<sup>9</sup>Note that if Baker stipulated that also Case assigners must pass a kind of Case Filter, i.e., they must assign their Cases, he could solve the latter problem.

derivation. All syntactic operations are feature-driven. Furthermore, the operations are guided by the *Earliness Principle* (Pesetsky 1989) which demands that an operation applies as soon as possible, i. e. as soon as the preconditions for the operation are met.

(18) *Strict Cycle Condition* (Chomsky 1973):

- a. No operation can apply to a domain dominated by a cyclic node  $\alpha$  in such a way as to affect solely a proper subdomain of  $\alpha$  dominated by a node  $\beta$  which is also a cyclic node.
- b. Every XP is a cyclic node.

A crucial difference between GB and Minimalism is that the latter has disposed with the notion of distinct syntactic levels of representation. D-structure and S-structure have amalgamated into incremental structure building in which the basic operations may freely apply and interact. According to Baker, such a framework seems incompatible with his theory of incorporation which he also understands as a good argument for the distinct levels of representation. Consider the following quotation (Baker 1988:428, emphasis added):

‘The status of D-structure [...] has been attacked from many perspectives. Lexical-Functional Grammar, Generalised Phrase Structure Grammar, and others dispense with such a level entirely, and GB theorists have explored the possibility of deriving it from S-Structure [...]. *Such approaches will be hard pressed to replicate or supersede the explanatory results of this work* in terms of lexical rules, linguistic meta-rules, or chain formation algorithms, without losing the essence and/or the elegance of the claim that there are no transformations that map syntactic structures onto other syntactic structures. *Thus, the existence and importance of D-Structure as a level of linguistic representation is reestablished by the theory of Incorporation.*’

One major advantage of a system that postulates something like Deep Structure as well as Surface Structure is that syntactic operations can be ordered by stipulating that they apply on different levels of grammar: at D-structure, S-structure or between D and S-structure.

In a Minimalist framework, there are no different levels of representation which lead to an order of operations. Hence, the order of Move and Agree (the Minimalist operations which lead to incorporation and agreement) must additionally be stipulated if Baker’s analysis is transferred one-for-one to Minimalism. In GB, movement applies between D-structure and S-structure while Case assignment is said to happen at S-structure. Thus, movement necessarily precedes Case assignment with the result that the verb can potentially agree with the possessor after the NP barrier is broken up by noun incorporation. This explanation, however, is not tenable in a Minimalist framework. Rather, in Minimalism, the relative order of most operations is regulated by the *Earliness Principle*.<sup>10</sup> In conjunction with incremental structure-building it forces agreement between N and Poss if the latter is selected by N. The reason is that there is a stage of the derivation where N has merged with Poss and NP is projected but V has not been merged yet:

(19) [NP POSS N]

<sup>10</sup>In certain cases it is unclear how to time two operations. If, e.g., a head has to Agree with two different categories, it is unclear which Agree operation applies first such that an extrinsic ordering is necessary. In the derivations below, such situations will not occur, i.e., we can derive the empirical data without help of an extrinsic ordering.

In this configuration, Agree between N and Poss is possible and given *Earliness*, it is forced. Hence, there is no way to get Case assignment between V and Poss because Poss is already Case-marked by N, i.e. V comes too late. If N always has to agree with Poss, it makes the wrong prediction that there could be a pattern in which N agrees with the possessor, consequently the verb agrees with N and N incorporates. This is, however, not attested, cf. 3.1. Baker could avoid early agreement between N and Poss because Case assignment/agreement applies at S-Structure after incorporation, so that V and N are both possible governors of Poss. Such a postponement is impossible in Minimalism given *Earliness*. Furthermore, even if one stipulated that agreement can be postponed to a point at which V is merged, an Agree relation between N and the possessor (which should be established if N does not incorporate, cf. 3.1) is impossible because of the *Strict Cycle Condition*. If the V head has already merged and projected the verb phrase, N can no longer assign Case to its sister Poss because this operation would affect the cyclic node NP which is dominated by a projection of V. So, the core problem is that at the point when NP is generated, it is not clear whether incorporation will apply later on or not.

The main question for a Minimalist analysis is thus how the delay of Case assignment within NP can be mimicked if (i) look-ahead is impossible and if (ii) the *Earliness Principle* and the *Strict Cycle Condition* hold.

Another problem for a Minimalist analysis is that in Minimalism, all operations are feature-driven (cf. the framework of Müller 2010).<sup>11</sup> This concerns especially the incorporation movement of N to V. Baker does not explicitly speak of a trigger for this movement but within the course of his discussion, it seems that in his understanding, the phonological form of the nominal head triggers movement. If  $N^0$  is realised by a bound affix, it is bound to move to V. In a framework that assumes a postsyntactic realisational morphology (Halle & Marantz 1993), the phonological form of a head cannot be taken as a trigger for its syntactic behaviour. Rather, the trigger must be a formal feature which triggers displacement of elements. We assume that this feature is a probe feature, represented as [ $*X*$ ] in the example below, which triggers an Agree relation, cf. the remarks in section 4.2. Basically, there are two different possibilities where the trigger could be located, namely (i) on the attracting head V (attracting movement, cf. (20-a)) or (ii) on the moving head N (greedy movement, cf. (20-b)).

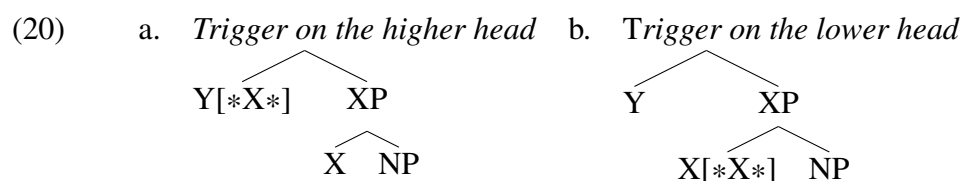

Neither of these options is per se to be preferred. The second one (21-b) is closer to what Baker (1988) assumes because the relevant phonological properties that trigger incorporation in his analysis are located on the lower head. We will follow him inasmuch as we locate the trigger on the lower head, too. The reasons for this assumption will become clear when we outline our analysis. We will then also discuss the exact nature of the trigger.

<sup>11</sup>An anonymous reviewer pointed out that this assumption is not adopted in Minimalism per se. See Boeckx (2010); Chomsky (2010, 2011) for non-feature-driven approaches.

The discussion so far has shown that if Baker's analysis is to be transferred to Minimalism, there are three tasks to be fulfilled: First, the technical problems which arise due to the different background assumptions of GB and Minimalism have to be solved; second, the stipulations that Baker needed as discussed in section 3.2 should be avoided, and finally, the empirical pattern laid out in section 3.1 is to be derived entirely.

#### 4.2. Background assumptions

In this section, we present our background assumptions for the Minimalist analysis of possessor advancement. Some of the technical problems discussed in the previous sections are solved by these assumptions alone. The empirical pattern is derived in section 4.3.

As already mentioned in 4.1, we draw on the standard Minimalist assumptions that (i) there are no distinct levels of representation, instead, the structure unfolds bottom up by alternating application of the basic operations Merge, Move, and Agree, (ii) all operations are feature-driven (Merge and Move are triggered by structure-building / c-selection features [ $\bullet F \bullet$ ], Agree is triggered by probe features [ $*F*$ ], for the notation see Sternefeld (2006); Heck & Müller (2007)), and (iii) syntactic operations are in accordance with the *Strict Cycle Condition* and the *Earliness Principle*.

Since in Baker's analysis of incorporation, the notion of *Government* plays an important role for case assignment and agreement, we make use of the Minimalist operation *Agree* as defined in (21) which encompasses some of the properties of government.

- (21) *Agree* (cf. Chomsky 2000, 2001)  
between a probe P and a goal G obtains if
- a. P c-commands G
  - b. P has a feature [ $*F*$ ] and G has a matching feature F
  - c. G is the closest matching goal for P.
- and
- d. G is active due to a feature [ $\cdot M \cdot$ ] and P has a matching feature [M]
- Then [ $*F*$ ] on P gets checked and deleted and [ $\cdot M \cdot$ ] on G gets checked and deleted.

Closeness is based on asymmetric c-command between multiple potential goals:

- (22) *Closeness*:  
In a configuration [P ... G<sub>1</sub> ... G<sub>2</sub>], G<sub>1</sub> is closer to P than G<sub>2</sub> if G<sub>1</sub> asymmetrically c-commands G<sub>2</sub>.

Agree is triggered by the principle of *Full Interpretation* (Chomsky 1986a; Chomsky 1995:27) which demands that all operation-triggering features (structure-building or probe features) must be checked at the end of the derivation, otherwise the structure cannot be interpreted at the interfaces.

- (23) *Full Interpretation*:  
A clause must not contain unchecked structure-building and/or probe features.

(24) provides a German sentence that exemplifies the definition of Agree in (21) for subject-verb agreement. This type of agreement is standardly analysed with a  $\varphi$ -probe on the functional head T (= P). This probe is checked by the  $\varphi$ -features of the subject in Specv (= G). The configuration fulfills all the conditions which are needed for Agree. Condition (21-a) is fulfilled since T c-commands the subject. Condition (21-b) is fulfilled because T needs to check  $\varphi$ -features while the subject has matching  $\varphi$ -features. Furthermore, the subject is the closest goal for the probe on T and it has an activating case feature [-case·] which finds a matching feature on T. Therefore, T can check its  $\varphi$ -probe and assign nominative case to the subject. The configuration is shown in (25).

(24) Du kaufst ein Fahrrad.  
 you.SG.NOM buy.2SG a bike  
 ‘You buy a bike.’

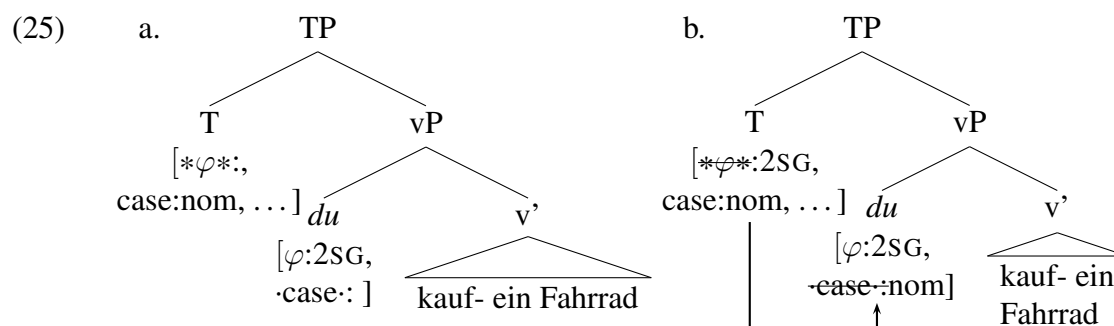

In addition to the definition in (21), we follow Heck (2010) in that the closest possible goal of a probe P on a head H is located on H itself. As Heck shows, G and P can be located on the same head if c-command is understood reflexively. This means that if there is a head H with a probe feature [ $*F*$ ] and a matching feature [F], these features enter into an Agree relation and are immediately satisfied and deleted.

(26)  $H [*F*, F] \longrightarrow H [*F*, F]$

The next crucial assumption concerns the trigger of incorporation, i.e. movement of N to V.<sup>12</sup> In general, movement of an element X is triggered by the need to check an operation-triggering feature with an element Y. However, X cannot check these features in its base position and therefore has to move to a position where it c-commands Y (Fanselow 2002). For noun incorporation, we take the trigger to be a case probe feature [ $*CASE*$ ] on N, the motivation for this assumption will become clear in the discussion below. There are thus two different activating Case features [-case·] and [ $*CASE*$ ]. Note that N can have only one of them, it may never receive more than one. Like the Case feature [-case·], the Case probe feature [ $*CASE*$ ] must be checked to fulfill *Full Interpretation*. In contrast to [-case·], however, it cannot be discharged as a by-product of Agree, but must c-command a matching goal, which is located on a Case assigner. Since N with [ $*CASE*$ ] does not c-command a Case assigner from its base position (unless it is a Case as-

<sup>12</sup>Throughout this paper, we take nominal arguments to be NPs instead of DPs (arguments for DP have been suggested by Abney (1987) and are widely adopted nowadays). We also take the Case assigner for the internal argument and the element which introduces the external argument, respectively, to be V instead of v, although the latter is the standard assumption in the Minimalist literature. We do this to stay close to Baker's (1988) assumptions. A discussion of the consequences of these assumptions and those which obtain if DP and v were chosen is provided in section 5.

signer itself), the N head is forced to move to a position where it c-commands the closest Case assigner V.

Following Matushansky (2006), we assume that head movement is basically the same as phrasal movement. Thus, in contrast to Baker's approach where head movement leads to adjunction at the higher head, head movement targets a specifier of the head into which it incorporates, just like phrasal movement.<sup>13</sup> In contrast to Matushansky (2006), however, we assume that the difference between phrasal movement and head movement is not the difference between Agree and C-Selection but the location of the trigger, i.e., head movement of a head H is triggered by a feature [*\*CASE\**] on the very same head H (cf. Fanselow 2002). Due to post-syntactic rules such as morphological merger, the verbal head is later on fused with its specifier leading to a single unit which consists of a nominal and a verbal head, but this postsyntactic step is of no importance for our analysis. This means that the N head moves to a specifier of V from where it c-commands the Case feature on V and can check its Case probe [*\*CASE\**].

Since we have now laid down our basic assumption, let us go through a sample derivation of noun incorporation in Mohawk. For reasons of simplicity, let us look at a case without a possessor:

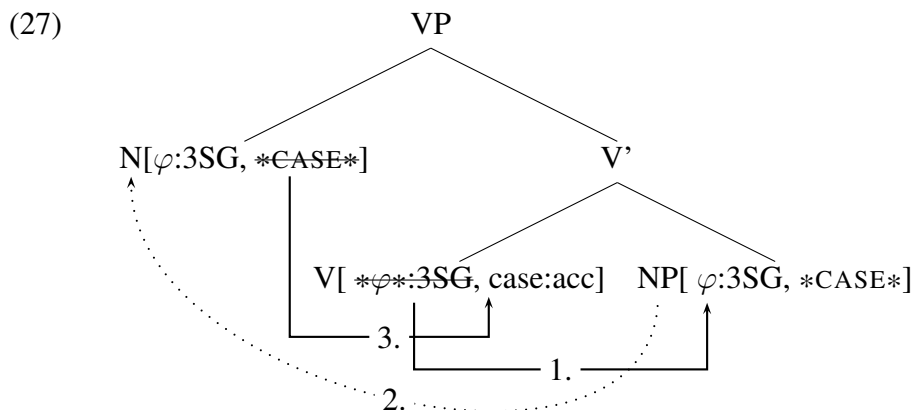

In (27), the verb selects an object which has a bundle of  $\varphi$ -features, in this case third person singular, and a probe Case feature [*\*CASE\**]. At first, the verb agrees with its object and checks the  $\varphi$ -feature probe [*\*φ\**]. If N had had a normal weak Case feature [*·case·*], the verb could have checked N's Case feature as well. But since N has a probe Case feature, it moves to the specifier of V where it checks its Case probe.<sup>14</sup>

The final assumption concerns the lexical properties of N. We have already said that N can have one of two activating Case features, [*·case·*] or [*\*CASE\**], which must be checked. In addition, N can select a possessor or not because arguments of nouns are generally optional. This is encoded by the presence vs. absence of the c-selection feature [*•N•*] for a possessor of category N. Finally, we assume that the property of N to be a Case assigner, which is necessary for Case marking NP-internal arguments, must be optional since arguments of N are optional

<sup>13</sup>We follow Matushansky (2006) in that head movement is movement to a specifier only for concreteness. An adjunction analysis à la Baker (1988) or a fusion-style analysis as in Roberts (2008, 2010) would work as well. What is indeed important for our analysis is that the trigger for incorporation is located on the incorporating element itself and c-commands the case assigner V from its landing site.

<sup>14</sup>Note that we assume that Case features on Case assigners do not have to be checked.

as well. If N was always a Case assigner but selected no argument, its case feature would be unchecked, and if N was never a Case assigner, its arguments would have no Case. This choice is encoded by the presence vs. absence of a Case value (in what follows this is the value GEN(itive) for the possessor) which goes hand in hand with providing a  $\varphi$ -probe [ $*\varphi*$ ] as Case assignment is defined as a by-product of Agree, cf. (21). Hence, there are three parameters which are independent of each other. This gives rise to eight different specifications of N.

(28) Possible specifications of N:

- I. N[·case·, case:GEN,  $*\varphi*$  ...]
- II. N[\*CASE\*, case:GEN,  $*\varphi*$  ...]
- III. N[·case·, ...]
- IV. N[\*CASE\*, ...]
- V. N[•N•, ·case·, ...]
- VI. N[•N•, \*CASE\*, ...]
- VII. N[•N•, ·case·, case:GEN,  $*\varphi*$  ...]
- VIII. N[•N•, \*CASE\*, case:GEN,  $*\varphi*$  ...]

As one can see from the fact that the N head has a [•N•] feature, cases (VI)-(VIII) are the ones with possessor and cases (I)-(IV) are the ones without. Cases (II), (IV), (VI) and (VIII) are the ones with a probe case feature which enables incorporation. And cases (I), (II), (VII) and (VIII) are the ones where N may assign genitive Case to its possessor.

With these background assumptions some of the problems discussed in the previous sections can automatically be solved. Let us start with the specification of N. Recall that we had to find a way to delay the assignment of genitive Case from N to Poss in some cases in order to be able to derive a configuration where V can Agree with Poss. Given the specifications of N in (28), it may be the case that N selects a possessor but does not provide a Case value for it (cases V and VI). When Poss receives no Case from N, it remains active for Case assignment from a head which is merged later on, e.g. the V head. The two trees below show the situation.

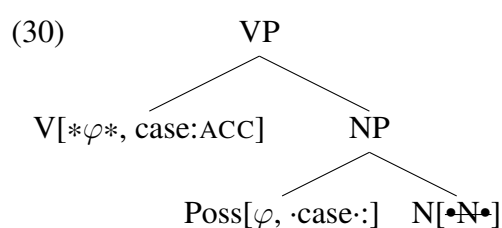
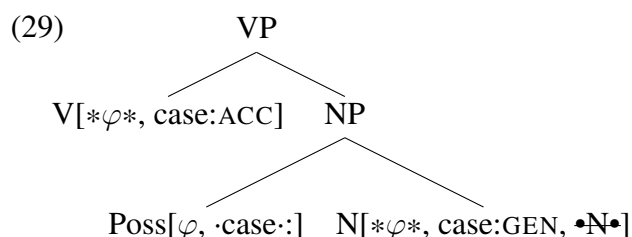

In both cases, N has a possessor but only in (29), it also has a Case-assigning genitive feature. In (29), the possessor is assigned genitive Case but in (30), it can in principle receive accusative Case assigned by the verb (depending on whether the head noun incorporates or not, cf. the derivations in section 4.3). Hence, there is no need to *postpone* Case assignment between N and the possessor (which is impossible given *Earliness*). Rather, in some cases, there is no Case assignment in the first place.

A second challenge for our analysis falls out from the assumptions about the feature specifications of N as well, and crucially, this is also the main motivation for assuming a Case feature

to trigger incorporation. Recall the empirical generalisation in (14) that if N incorporates, it cannot agree with the possessor. This is derived as follows: N can be a Case assigner or not and it can have a probe Case feature [*\*CASE\**] triggering incorporation or a Case feature [*-case·*] which is checked and valued as a by-product of Agree. In conjunction with the assumption that the goal for a probe can be located on the same head as the probe (Heck 2010), we can see that if N is a Case assigner and has a probe Case feature [*\*CASE\**], this probe Case feature is immediately satisfied by the valued Case feature [*case:GEN*] on N. Since [*\*CASE\**] is the trigger for incorporation, it follows that N which agrees with Poss, i.e., assigns genitive Case, can never incorporate, cf. the generalisation in (14) for Mohawk. This incompatibility of Case assignment and movement falls out if the movement trigger is a feature which is the counterpart of the valued Case feature, namely a probe Case feature, such that one checks the other and the checked feature cannot have an impact on the derivation. This is the empirical motivation for our assumption that the movement trigger is a Case feature.

A conceptual argument for the assumption that a Case feature triggers incorporation of a head into its case assigner is that in our view, this is a consistent extension of an already existing contrast. In some languages, long-distance case assignment is sufficient to assign Case, just like in the Finnish example in (31) where the case of the embedded object depends on whether the matrix verb is negated (only partitive case is possible) or not (accusative or partitive case possible). Case assigner and Case assignee can be separated by other elements. However, in a language like English, adjacency is a necessary condition for Case assignment (32).

(31) *Long-distance Case assignment*

- a. Pekka uskoi Merjan olevan syömässä leivän/ leipää  
 Pekka believed Merja be.VA eat.MA bread.ACC bread.PRT  
 ‘Pekka believed Merja to be eating bread.’
- b. Pekka ei uskonut Merjan olevan syömässä \*?leivän/ leipää  
 Pekka not believe Merja be.VA eat.MA bread-ACC bread-PRT  
 ‘Pekka did not believe Merja to be eating the bread.’ Brattico (2011:1055)

(32) *Case assignment under adjacency:*

- a. Poirot speaks English fluently.
- b. \*Poirot speaks fluently English. Haegeman (1994:178)

If languages differ from each other with regard to the locality domain of Case assignment, it is plausible that there is a third possible type, namely Case assignment under structural identity, i.e., within the same phonological word. These cases are generally known as cases of incorporation, as the example in (33) from Greenlandic Eskimo shows:

(33) *Case assignment under structural identity:*

- Suulut timmisartu-lior-poq  
 Søren.ABS airplane-make-3SG.S  
 ‘Søren made an airplane.’ Baker (1988:126)

To sum up, we have found a trigger for incorporation, we derived the generalisation in (14) and we found a way to ‘delay’ Case assignment to the possessor. What remains to be done is to show how the empirical pattern of agreement is derived and what stipulations of Baker (1988) can be avoided. To see how this is achieved we will go through all logically possible derivations



in detail in the next section. Recall that due to the three parameters on N (N selects a possessor or not, N is a Case assigner or not, N incorporates or not) there are eight possible specifications and thus eight possible derivations. The following table gives an overview of all eight cases and illustrates which properties are combined, compare (28). Furthermore, it is supplemented by the last column which indicates whether the specific case will result in an attested pattern (+) or not (-).<sup>15</sup>

(34) 8 cases:

	Poss?	[case:GEN]?	Incorp?	Attested Pattern?
Case I	-	+	-	-
Case II	-	+	+	-
Case III	-	-	-	+
Case IV	-	-	+	+
Case V	+	-	-	-
Case VI	+	-	+	+
Case VII	+	+	-	+
Case VIII	+	+	+	-/+

#### 4.3. The derivations

In the previous section, we have proposed that all empirical cases found in Mohawk can be derived by assuming different feature specifications on the head noun. We assume that the noun is specified for (i) whether it selects a possessor or not, for (ii) whether it assigns genitive Case or not and for (iii) whether it incorporates or not. By cross-classifying these three binary variables, we end up with eight possible cases. The basic idea is that all eight differently specified Ns can enter the derivation, but only some of the derivations converge, the others crash because they violate general conditions on feature checking (e.g. *Full Interpretation*) or on the application of syntactic operations (e.g. *the Strict Cycle*). The result is that the converging cases are exactly the ones which are attested patterns in Mohawk. Cases I to IV are those without a possessor, Cases V to VIII are the ones with a possessor.

##### CASE I:

In the first case, N has no possessor, it has no probe case feature [*\*CASE\**] and will thus not incorporate. However, it assigns genitive Case. In this derivation V can agree with N and assign accusative Case to it, but there is no NP which can receive the genitive Case from the head noun by  $\varphi$ -Agree with N. The derivation thus crashes because of a violation of *Full Interpretation* (cf. (23)): the  $\varphi$ -probe on N is unchecked.

<sup>15</sup>The table in (i) implies that Case VIII is a special case here yielding a pattern that is at the same time attested and unattested. Since the feature specification combines a feature [*\*CASE\**] with a  $\varphi$ -probe, one would predict that incorporation applies together with genitive Case assignment. This pattern would be unattested. But as will become clear in the next section, only genitive Case assignment but no incorporation occurs. This pattern is in fact attested.



CASE IV:

In this case, N has no possessor, it does not assign Case but it has a probe Case features and will thus incorporate. There are two possible ways to run the derivation. In option (i), the first step is the incorporation of N into V. This derivation crashes because afterwards, V cannot agree with N and check its  $\varphi$ -probe because Agree requires that the probe c-commands the goal which is not given if N has incorporated into V and is located in SpecV. Hence, the unchecked  $[\ast\varphi\ast]$  causes a violation of *Full Interpretation*. Option (ii) is that first V and N agree whereby the  $\varphi$ -probe on V is checked. In a second step, N moves into the specifier of V where it checks its probe Case feature. This derivation converges because all probe features are checked.

(38) Case IV: no poss, no Case-assigning property on N, incorp

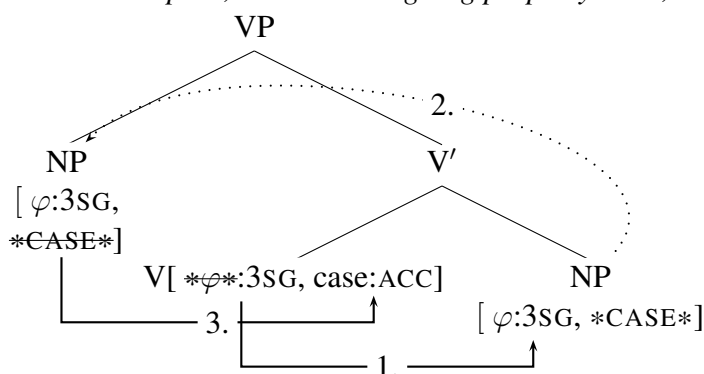

CASES I to IV instantiate all possible combinations without a possessor. What we have derived is the first part of the empirical generalisation in (13): if there is no possessor the verb agrees with the head noun regardless of whether incorporation applies or not (cf. cases III and IV).

CASE V:

N selects a possessor. However, it neither assigns Case nor does it incorporate. This derivation is bound to crash because there is only one Case assigner, namely V, but two Ns which need Case, namely the possessor and the head noun. One of the nominal elements cannot check its Case feature because V is saturated and inactive after Agree with the other nominal element. Again, *Full Interpretation* is violated by one of the two  $[\ast\varphi\ast]$ -features.

(39) \*Case V: poss, no Case-assigning property on N, no incorp:

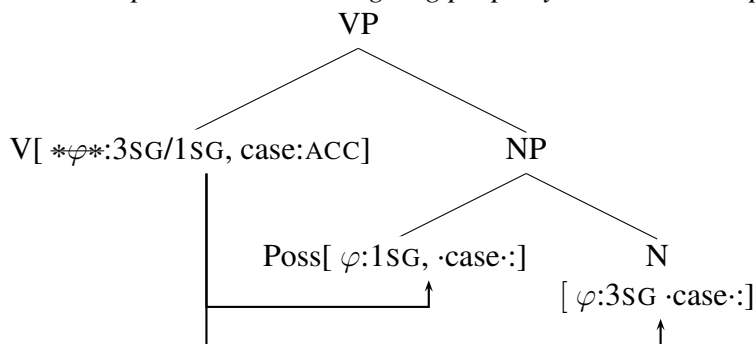

CASE VI:

N selects a possessor but does not assign Case; it has a probe Case feature, i.e. it incorporates. There are two ways to run the derivation because since N cannot Agree with Poss, both N

and Poss are possible goals for V given that none is closer to V than the other (N and Poss c-command each other, hence there is no asymmetric c-command between them and they are equally close to V, cf. (21) and (22)). In option (i), V agrees with N and N values V's  $\varphi$ -probe, N is assigned accusative Case. Afterwards, N incorporates. This derivation crashes because the possessor, being an NP, also needs a Case value via  $\varphi$ -Agree. But as N has saturated the  $\varphi$ -probe on V, the possessor cannot agree with V and the feature [-case·] of the possessor is unchecked. Option (ii) is that V agrees with the possessor which is assigned accusative Case and values the  $\varphi$ -features on V. The head noun incorporates and thereby checks its probe Case feature. The result of this derivation is the classical possessor ascension structure:<sup>17</sup>

(40) Case VI: poss, no Case-assigning property on N, incorp:

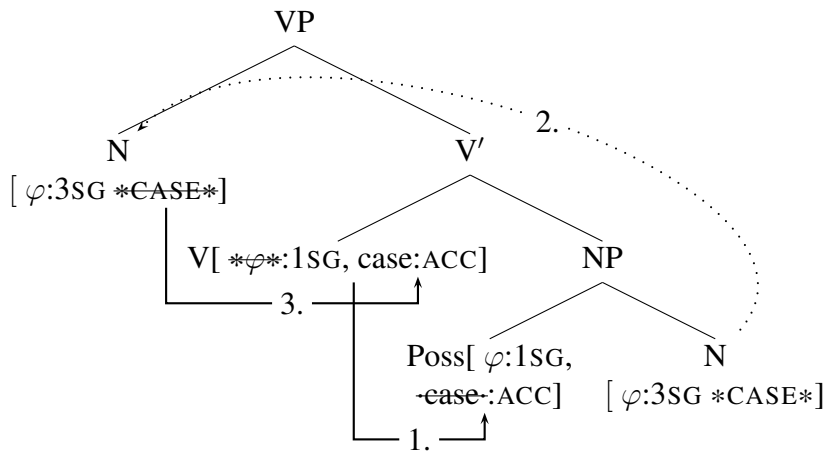

CASES V and VI only differ in the Case feature on N ([-case·] vs. [\*CASE\*]), i.e., with respect to whether N incorporates or not. In both cases, V can potentially agree with the possessor because there is no NP-internal Agree between N and Poss given that N has no Case to assign. What is derived is that if the verb agrees with the possessor, the head noun *must* incorporate (Case VI) otherwise it would keep an unvalued case feature (Case V).

#### CASE VII:

In this case, N selects a possessor, it assigns Case and has no probe Case feature, i.e., it will not incorporate. This derivation converges: first, before the verb has even entered the derivation, the N head agrees with the possessor and assigns genitive Case to it, N bears the  $\varphi$ -features of the possessor. As a result, the possessor is saturated and thus inactive for further Agree so that V can only agree with N in the second step. V's  $\varphi$ -probe is checked by N and N receives accusative Case. This is the classic configuration with a possessor but without incorporation: N-Poss-Agree, V-N-Agree.

<sup>17</sup>For sake of convenience, we assume a simple NP structure where Poss is the sister of  $N^0$ . We are aware of the fact that the structure might be more complex than we have indicated in our trees, i.e., it may include further projections, but the point of the argument stays the same: if Poss is merged in a higher position and asymmetrically c-commands  $N^0$ , option (i) becomes impossible. Instead option (ii) would be the only possible derivation. See section 5 for further discussion.

(41) Case VII: poss, Case-assigning property on N, no incorp:

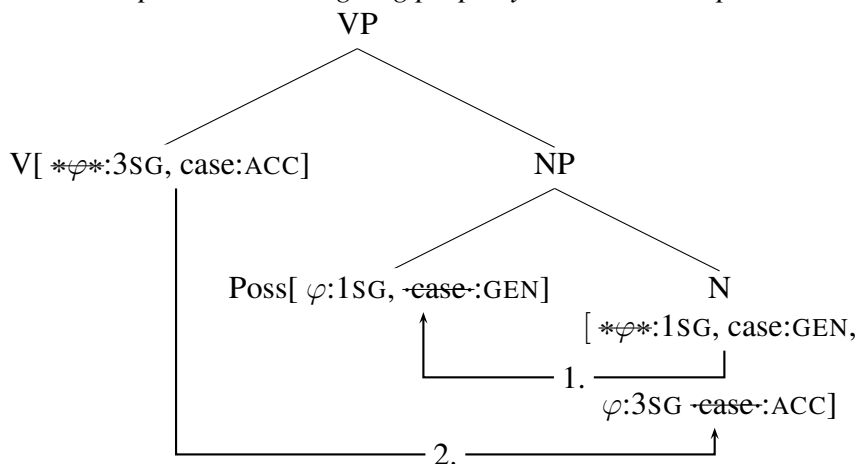

CASE VIII:

In the final case, N selects a possessor, assigns Case and has an incorporation-triggering probe Case feature. At first sight, it seems that this derivation can converge: first, N and the possessor agree so that the latter is assigned genitive Case and N bears the  $\phi$ -features of the possessor. Then, V agrees with the remaining goal N and assigns accusative Case to it. Finally, N incorporates to check its probe Case feature. This would derive a pattern with V-N-Agree, N-Poss-Agree and incorporation. However, such a pattern is not attested; the two latter operations contradict the generalisation in (14). But note that this contradiction does indeed not arise because one important step in the derivation just sketched is missing. Recall that the closest goal for a probe can be located on the same head as the probe. This is exactly the situation for the Case probe on N. Since N is also a Case assigner, viz. provides a Case value [case:GEN], the Case probe on N is already satisfied before the derivation starts (cf. CASE II in (36)). As a result, N cannot incorporate — the trigger for this movement is already checked and deleted. After this initial step, the derivation is identical to (41). At first, N assigns genitive Case to its possessor, afterwards it agrees with V. Thus, the derivation coincides with CASE VII, the outcome looks as if there has never been a movement-triggering feature in the first place.

(42) Case VIII: poss, Case-assigning property on N, incorp

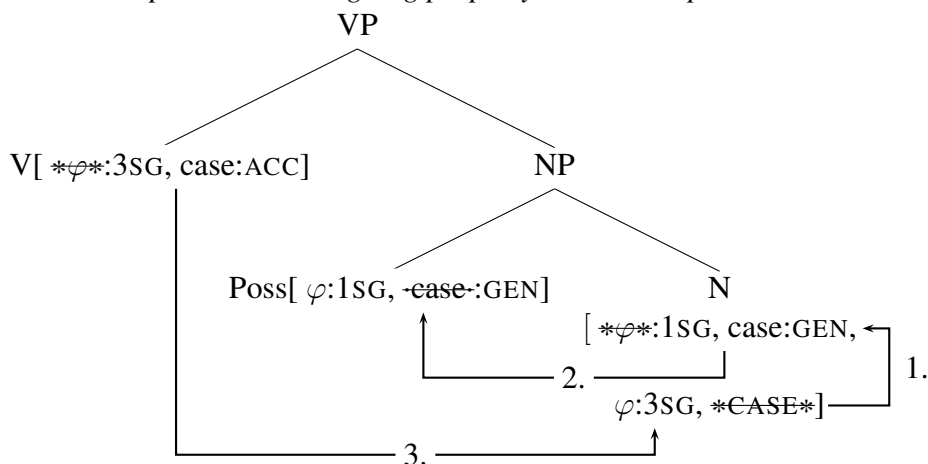

CASES VII and VIII only differ in the Case feature on N ([·case·] vs. [\*CASE\*]), i.e., with respect to whether N incorporates or not. What is derived is that if the V-N-Agree is forced due to the deactivation of the possessor by N-Poss-Agree, N *must not* incorporate, cf. the generalisation in (14). Incorporation is excluded because the movement-triggering feature is deactivated by the Case value N provides for the possessor and it thus never has an effect on the derivation.

At this point, it becomes clear that the converging cases cover the complete paradigm of noun incorporation and possessor ascension in Mohawk, whereas the crashing derivations are the cases which would lead to an unattested pattern. The only exception to that rule is case VIII which does not crash but whose converging outcome coincides with case VII. Although both derivations have a different input, the resulting output is identical. N-Poss-Agree and incorporation of N can never cooccur in a derivation due to the early checking relation between the two features which trigger these operations. We have thus derived the full pattern of agreement under noun incorporation in Mohawk as presented in section 3.1.

#### 4.4. *Advantages of the present analysis*

In this section, we briefly summarise the achievements of our analysis of possessor advancement.

First of all, we have shown that the problems which arise due to the different background assumptions of GB and Minimalism can be solved. We provided an account of the facts in a strictly derivational framework without multiple levels of representation, something which Baker believed to be impossible. Second, we defined a trigger for incorporation which was necessary because in Minimalism, all operations are feature-driven (cf. fn. 11). We followed Baker in that the trigger for incorporation is a property of the head noun, not of the attracting head. We have taken it to be a probe Case feature which forces the head noun to move into the specifier of its Case assigner. This allows us to derive the connection between incorporation and N-Possessor-Agree in (14). In Baker's approach, incorporated nouns do not need Case because he stipulated that incorporation is another way to satisfy the Case filter. In the present approach, incorporated Ns check their probe Case feature via incorporation. Third, the core problem, namely the postponement of Case assignment to the possessor is solved because N only *optionally* assigns Case. If N does not assign Case, the possessor can be a goal for Agree with the higher head V which is merged later. If N does assign Case, this assignment still happens as soon as possible in accordance with the *Earliness Principle*.

Furthermore, we can avoid several stipulations Baker had to make. First, we do not have to assume that traces or — their Minimalist counterpart — copies of the moved noun cannot assign Case since it falls out from the analysis that if N incorporates it cannot be a Case assigner in the first place (because the valued Case feature deletes the incorporation-triggering feature before the derivation starts). If N is not a Case assigner, then it is obvious that the lower copy / the trace of N is also not a Case assigner.

The second stipulation of Baker, the *Case Frame Preservation Principle* in (16) which states that the incorporated item loses its ability to assign Case, follows automatically in our analysis in the same way: If N incorporates, it cannot be a Case assigner in its base position and thus also not in its landing site.

Finally, we have derived the complete empirical agreement pattern of noun incorporation in Mohawk. Baker did not explicitly discuss why some cases of the pattern are not derivable in his system.

### 5. Problems and open questions

In this section, we shortly discuss possible problems and questions for the analysis of section 4.

#### *Structure of nominal phrases:*

The first discussion concerns the structure of nominal phrases. Above, we have assumed that nominal phrases are headed by N in contrast to theories that assume nominal phrases are headed by a functional head D. Such a structure would be incompatible with our analysis because in a DP structure, the Case feature would have to be located on D given that DPs are phases (cf. Svenonius 2004; Heck & Zimmermann 2004). Therefore, the feature [\*CASE\*] ceases to be a trigger of N-movement. In addition, either the interaction between the feature [\*CASE\*] and the feature [case: gen] is lost if the Case-assigning feature [case: gen] is still located on N, or wrong empirical predictions are made: instead of nouns, determiners would incorporate into verbs. This, however, is not possible as the sentence in (43) shows. Demonstratives, which are standardly analysed to be D elements, must be stranded by noun incorporation.

- (43) a. Ka-ravk thikv ka-nuhs-a?  
           3N-white that PRE-house.N-SUF  
           ‘That house is white.’  
       b. Ka-nuhs-rakv thikv.  
           3N-house.N-white that  
           ‘That house is white.’
- Baker (1988:97)

However, recent work has shown that the facts which were thought to argue for the DP hypothesis can also be derived by means of an NP structure if certain assumptions are made. See Bruening (2009); Georgi & Müller (2010) for independent arguments for an NP structure of nominal phrases.

A second putative problem for our account are theories in which possessors are selected by heads other than N. Especially if possessors do not get Case from N but from some other category, the generalisation that N does not incorporate if the possessor has genitive case seems to be lost. Note, however, that our theory predicts that N would incorporate into this head which is empirically confirmed by the data in Mohawk, where agreement with the possessor shows up as an affix at the head noun rather than as some independent particle. Thus, a more complicated structure for possessor construction is not necessarily incompatible with our approach.

#### *Argument structure:*

In standard Minimalist analyses, not V but v is the head that assigns Case to the direct object and V incorporates into v. Such a structure is compatible with our account of noun incorporation since there is at least one order of operations that leads to a converging derivation: (i) v agrees with Poss; (ii) V incorporates into v; (iii) N incorporates into V+v. Note that this order obeys

all the Minimalist assumptions made in section 4. We used a structure without *v* for the sake of simplicity.

*Incorporation in intransitive constructions:*

Empirically, the difference between unergative and unaccusative verbs concerning noun incorporation is that the only argument of unaccusative verbs can incorporate into verbs while the only argument of unergatives cannot do so (Baker 1988:82ff.). In our analysis, the only Case assigner in intransitive constructions is T — the minimalist equivalent of GB's I — which assigns nominative Case. The only argument of an intransitive verb has to incorporate into T. As far as we can see, such an incorporation should be possible for both unaccusative and unergative subjects. Therefore, the asymmetry between both kinds of intransitive constructions does not follow from our analysis. Note that Baker can derive this pattern but his solution is based on the assumptions that there is only *one* subject position, namely SpecI. Arguments in SpecI cannot incorporate into I or V since this movement would leave a trace that is not c-commanded by its antecedent (Baker 1988:83). However, if there is a subject position below I, (e.g. in theories which adopt a VP-internal subject position, cf. e.g. Kitagawa 1986; Kuroda 1988; Koopman & Sportiche 1991), the asymmetry between unergatives and unaccusatives cannot be derived in Baker's account either because nothing prevents the external argument from incorporating into I. To transfer the analysis to our Minimalist analysis, one would have to assume, that V/*v* rather than T assigns nominative Case. Thus, the generalisation about intransitive verbs is neither derived by Baker's mechanism of incorporation nor by ours. The success of the respective analyses solely depends on the existence of a low subject position.

## 6. Conclusion and outlook

The main aim of this paper was to examine whether Baker's (1988) approach to possessor advancement can be transferred to a derivational Minimalist framework that obeys the *Strict Cycle Condition* (Chomsky 1973) and the *Earliness Principle* (Pesetsky 1989). According to Baker, his approach cannot be transferred to a syntactic framework without distinct levels of syntactic representation such as GB's D-structure and S-structure. However, as far as we can see, this claim can be refuted since the approach presented in this paper is not only able to transfer the major ideas of Baker to a more modern derivational framework without distinct levels but it also derives the empirical pattern of noun incorporation in Mohawk more accurately. Of course, a few adaptations were necessary because a simple copying of Baker's mechanisms leads to several technical problems, for example the 'timing problem' which appeared since Minimalism does not allow the delay of operations such as Case assignment to a later step in the derivation. We provided solutions to these problems which are in line with standard Minimalist assumptions. In addition, the stipulations Baker has to make in order to make his account work can be avoided in the Minimalist reanalysis.

Of course, Baker's (1988) analysis of noun incorporation and possessor ascension in Mohawk was just a small part of his comprehensive approach to a big set of incorporation phenomena in the world's languages. A main aim of his theory was to relate every grammatical function changing process to a specific type of incorporation such as causativisation to verb incorporation



and applicativisation to preposition incorporation. So the question arises whether our Minimalist reanalysis of Baker's approach can in principle be transferred to these phenomena as well. We think that this should be possible given the observation that all of the categories that, according to Baker, may incorporate into the next higher verb, are also Case assigners, namely verbs, prepositions and nouns. Our analysis makes use of this fact by assuming that Case assignment and incorporation cannot cooccur and the same holds for causativisation and applicativisation. However, a few adaptations probably have to be made since verbs and prepositions are usually not Case-marked; only N is. These GFCEs definitely deserve closer investigation with respect to our analysis of noun incorporation.

#### *Acknowledgements*

For valuable comments we would like to thank the participants of the class on polysynthesis (University of Leipzig, summer term 2010), the participants of the syntax colloquium at the University of Leipzig, as well as the audience of ConSOLE XIX (Groningen, January 2011). In particular, we are indebted to Fabian Heck, Stefan Keine, Gereon Müller and Martin Salzmann and an anonymous reviewer for fruitful discussions.

This research was partly funded by the DFG (Deutsche Gemeinschaft für Forschung) within the project *Nicht-lokale Modellierung nicht-lokaler Abhängigkeiten in der Syntax* ('non-local modeling of local dependencies in syntax') and the research group *Grammatik und Verarbeitung verbaler Argumente* ('grammar and processing of verbal arguments').

Anke Assmann  
Universität Leipzig  
[anke.assmann@uni-leipzig.de](mailto:anke.assmann@uni-leipzig.de)  
<http://www.uni-leipzig.de/~assmann>

Doreen Georgi  
Universität Leipzig  
[georgi@uni-leipzig.de](mailto:georgi@uni-leipzig.de)  
<http://www.uni-leipzig.de/~georgi>

Philipp Weisser  
Universität Leipzig  
[philipp.weisser@uni-leipzig.de](mailto:philipp.weisser@uni-leipzig.de)  
<http://www.uni-leipzig.de/~phweisser>

## References

- Abney, S. (1987). *The English Noun Phrase in Its Sentential Aspect*. Ph.D. thesis, MIT, Cambridge, Massachusetts.
- Aissen, J. (1987). *Tzotzil Clause Structure*. Studies in Natural Language and Linguistic Theory, Reidel, Dordrecht.
- Allen, B. & D. Frantz (1978). Verb Agreement in Southern Tiwa. *Berkeley Linguistics Society* 4, pp. 11–17. [Revised version: Advancements and Verb Agreement in Southern Tiwa. Studies in Relational Grammar 1, ed. by David Perlmutter, 303–14. Chicago: University of Chicago Press, 1983.]
- Baker, M. (1996). *The Polysynthesis Parameter*. Oxford University Press, New York.
- Baker, M. C. (1988). *Incorporation: A Theory of Grammatical Function Changing*. University of Chicago Press Chicago.
- Blake, B. J. (1990). *Relational Grammar*. Routledge, London.
- Boeckx, C. (2010). Defeating Lexicocentrism. Ms. ICREA/UAB.
- Brattico, P. (2011). Case Assignment, Case Concord, and the Quantificational Case Construction. *Lingua* 121, pp. 1042–1066.
- Browning, M. (1989). *Null Operator Constructions*. Ph.D. thesis, MIT, Cambridge, Massachusetts.
- Bruening, B. (2009). Selectional Asymmetries between CP and DP Suggest that the DP Hypothesis is Wrong. *UPenn Working Papers in Linguistics* 15, pp. 26–35.
- Chomsky, N. (1973). Conditions on transformations. Anderson, S. & P. Kiparsky (eds.), *A Festschrift for Morris Halle*, Academic Press, New York, pp. 232–286.
- Chomsky, N. (1980). On Binding. *Linguistic Inquiry* 11:1, pp. 1–46.
- Chomsky, N. (1981). *Lectures on Government and Binding: The Pisa Lectures*. Mouton de Gruyter.
- Chomsky, N. (1986a). *Barriers*, vol. 13 of *Linguistic Inquiry Monograph*. MIT Press, Cambridge, Massachusetts.
- Chomsky, N. (1986b). *Knowledge of Language: Its Nature, Origins, and Use*. Praeger, New York.
- Chomsky, N. (1995). *The Minimalist Program*. MIT Press.
- Chomsky, N. (2000). Minimalist Inquiries. Martin, D. M., Roger & J. Uriagereka (eds.), *Step by step: Essays on Minimalism in Honor of Howard Lasnik*, MIT Press, pp. 89–155.
- Chomsky, N. (2001). Derivation by Phase. Kenstowicz, M. (ed.), *Ken Hale: A Life in Language*, MIT Press, pp. 1–52.
- Chomsky, N. (2008). On Phases. Robert Freidin, C. P. O. & M. L. Zubizarreta (eds.), *Foundational Issues in Linguistic Theory. Essays in Honor of Jean-Roger Vergnaud*, MIT Press, pp. 133–166.
- Chomsky, N. (2010). Restricting Stipulations: Consequences and Challenges. Talk given at the University of Stuttgart, March 27th 2010.
- Chomsky, N. (2011). Problems of Projection. Talk given at the University of Leiden, March 14th 2011.
- Fanselow, G. (2002). Münchenhausen-Style Head Movement and the Analysis of Verb Second. A. Mahajan, Hg., *Proceedings of the Workshop on Head Movement. Los Angeles: UCLA, Linguistics Department*.
- Frantz, D., D. Gardiner & D. Perlmutter (1990). *Verb Agreement, Possessor Ascension, and Multi-stratal Representation in Southern Tiwa*. Studies in Relational Grammar 3, University of Chicago Press, Chicago.
- Georgi, D. & G. Müller (2010). Noun-Phrase Structure by Reprojection. *Syntax* 13:1, pp. 1–36.
- Haegeman, L. M. (1994). *Introduction to Government and Binding Theory*. Wiley-Blackwell.
- Halle, M. & A. Marantz (1993). Distributed Morphology and the Pieces of Inflection. Hale, K. & S. J. Keyser (eds.), *The View from Building 20*, MIT Press.
- Heck, F. (2010). Categories, Recursion and Bare Phrase Structure. handout, GGS 2010.
- Heck, F. & G. Müller (2007). Extremely Local Optimization. Brainbridge, E. & B. Agbayani (eds.), *Proceedings of WECOL 26*, California State University, Fresno, pp. 170–183.
- Heck, F. & M. Zimmermann (2004). DPs as Phases. Ms., Universität Leipzig and HU Berlin.
- Kitagawa, Y. (1986). *Subjects in Japanese and English*. Ph.D. thesis, University of Massachusetts, Amherst.
- Koopman, H. & D. Sportiche (1991). The Position of Subjects. McCloskey, J. (ed.), *The Syntax of Verb-Initial Languages*, Elsevier, pp. 211–259.
- Kuroda, S.-Y. (1988). Whether We Agree or not: A Comparative Syntax of English and Japanese. *Linguisticae Investigationes* 12, pp. 1–47.
- Markman, V. G. (2009). On the Parametric Variation of Case and Agreement. *Natural Language and Linguistic Theory* 27:2, pp. 379–426.
- Matushansky, O. (2006). Head Movement in Linguistic Theory. *Linguistic Inquiry* 37:1, pp. 69–109.

- Müller, G. (2010). On Deriving CED Effects from the PIC. *Linguistic Inquiry* 41:1, pp. 35–82.
- Pesetsky, D. (1989). The Earliness Principle. Ms.
- Řezáč, M. (2004). Agree and Merge. Ms. University of the Basque Country.
- Roberts, I. (2008). A Deletion Analysis of Null Subjects: French as a Case Study. Ms., University of Cambridge. Forthcoming in: Holmberg, A. & I. Roberts (eds.). *Null Subjects: The Structure of Parametric Variation*. Cambridge: CUP.
- Roberts, I. (2010). *Agreement and Head Movement: Clitics, Incorporation, and Defective Goals*. MIT Press.
- Robinson, B. (1980). Possessor Ascension in Universal Grammar. *Toronto Working Papers in Linguistics* 1, pp. 108–140.
- Rosen, C. (1990). Rethinking Southern Tiwa: The Geometry of a Triple-Agreement Language. *Language* 66:4, pp. 669–713.
- Rouveret, A. & J.-R. Vergnaud (1980). Specifying Reference to the Subject: French Causatives and Conditions on Representations. *Linguistic Inquiry* 11:1, pp. 97–202.
- Sternefeld, W. (2006). *Syntax*. Stauffenburg, Tübingen. Two volumes.
- Svenonius, P. (2004). On the Edge. Adger, D. and de Cat, C. and Tsoulas, G. (ed.), *Peripheries: Syntactic Edges and their Effects*, Kluwer, pp. 261–287.